

# SIRUBA®

銀命牌工業用縫紉機

INDUSTRIAL SEWING MACHINE

# 700FS

## 零件圖 PARTS LIST











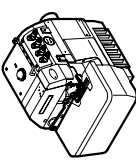

































From the library of: Diamond Needle Corp

CE



高林股份有限公司  
KAULIN MFG. CO., LTD.

	GAUGE																			
737FS-505F1-04	4	E304	D103	D102	H104	1.6	P152D-3	—	LP26	KG131	KF25	KJ09B	KJ10	#9	5.5			KL62	KL11	8000
737FS-505F1-04/ESS	4	E304	D103	D102	H104	1.6	P152D-3	—	LP26	KG131	KF25	KJ09B	KJ10	#9	5.5			KL62	KL11	8000
737FS-505F1-04/VT	4	E304	D103	D102	H104	1.6	P152D-3	—	LP26	KG131	KF25	KJ09B	KJ10	#9	5.5			KL62	KL11	8000
737FS-505F1-04/ESS/VT	4	E304	D103	D102	H104	1.6	P152D-3	—	LP26	KG131	KF25	KJ09B	KJ10	#9	5.5			KL62	KL11	8000
737FS-504M2-04	4	E324	D117	D116	H118	1.6	P987-3	KS62	LP26	KG131	KF26	KJ11B	KJ13	#11	6.5			KL60	KL11	6300
737FS-504M2-04/VT	4	E324	D117	D116	H118	1.6	P987-3	KS62	LP26	KG131	KF26	KJ11B	KJ13	#11	6.5			KL60	KL11	6300
737FS-504M2-04/LFC-2S	4	E324	D117	D116	H118	1.6	P111-3	KS62	LP26	KG131	KF26	KJ11B	KJ13	#11	6.5			KL60	KL11	6300
747FS-514M2-24	2	E434	D117	D116	H118	1.6	P987-4	KS62	LP26	KG142	KF26	KJ11B	KJ13	#11	5.5			KL60	KL11	6000
747FS-514M2-24/VT	2	E434	D117	D116	H118	1.6	P987-4	KS62	LP26	KG142	KF26	KJ11B	KJ13	#11	5.5			KL60	KL11	6000
747FS-514M2-24/CT	2	E424	D103	D116	H118	1.6	P987-4	KS62	LP26	KG142	KF26	KJ11B	KJ13	#11	5.5			KL60	KL11	6000
747FS-514M4-24	2	E424	D103	D116	H118	1.6	P987-4	KS62	LP26	KG142	KF25	KJ69	KJ10	#11	6.5			KL62	KL11	7500

# PARTS LIST FOR KA GROUP

# PARTS LIST FOR KB GROUP

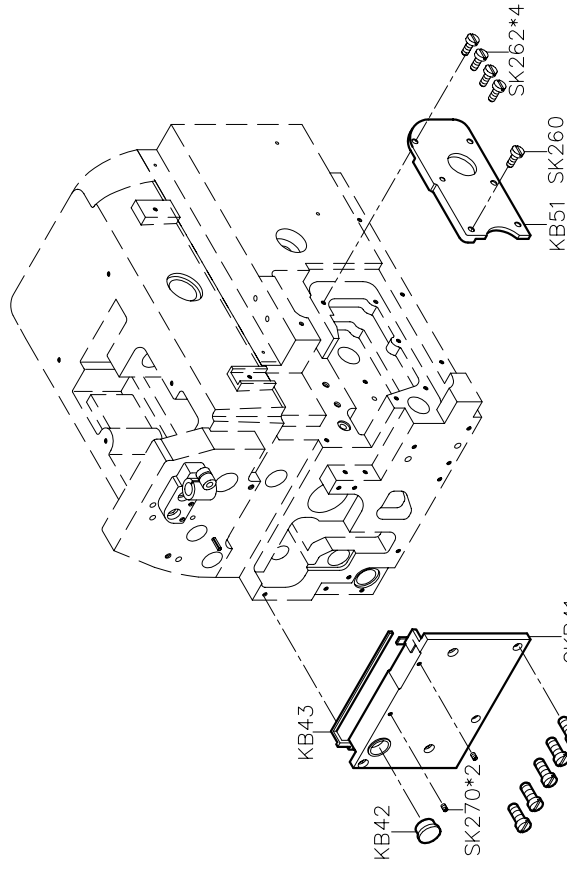
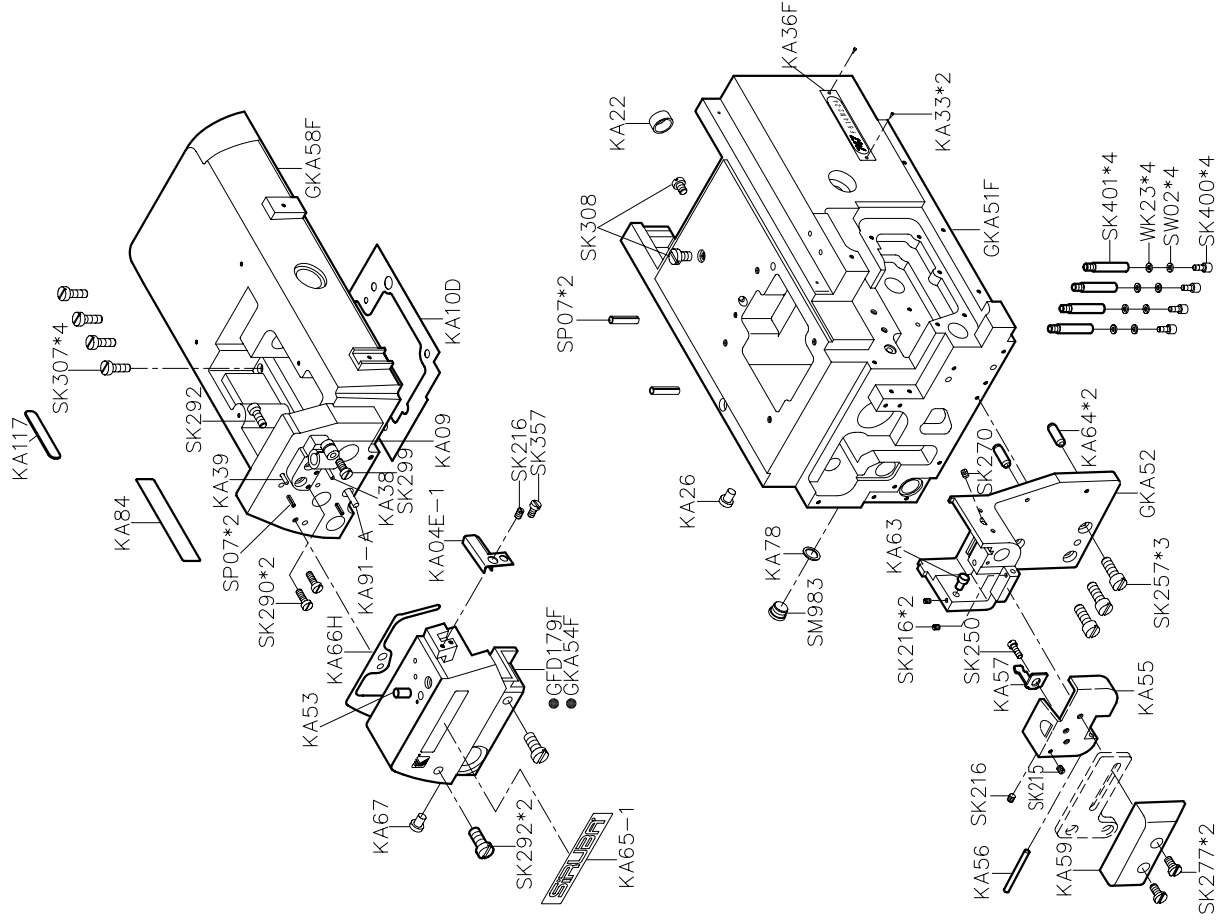

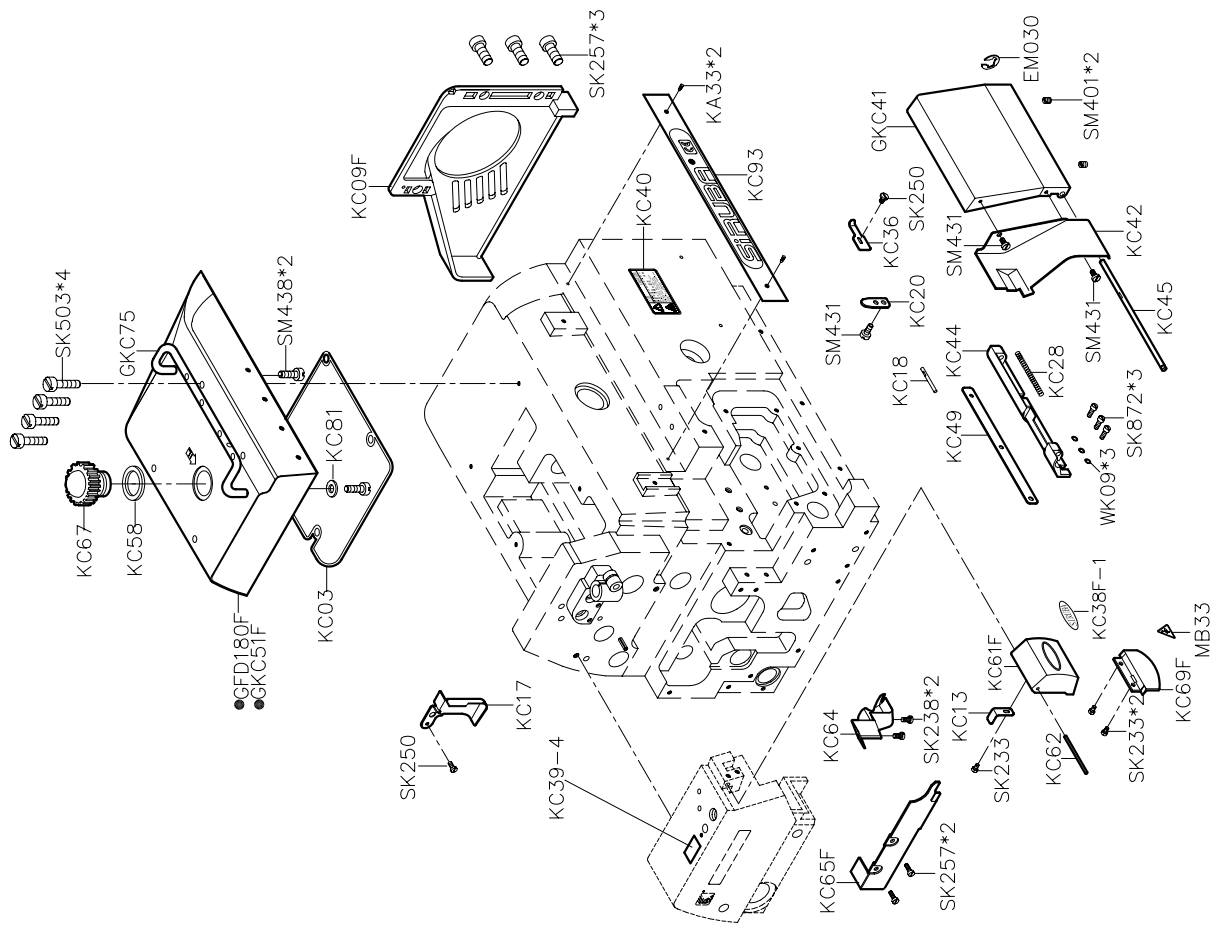
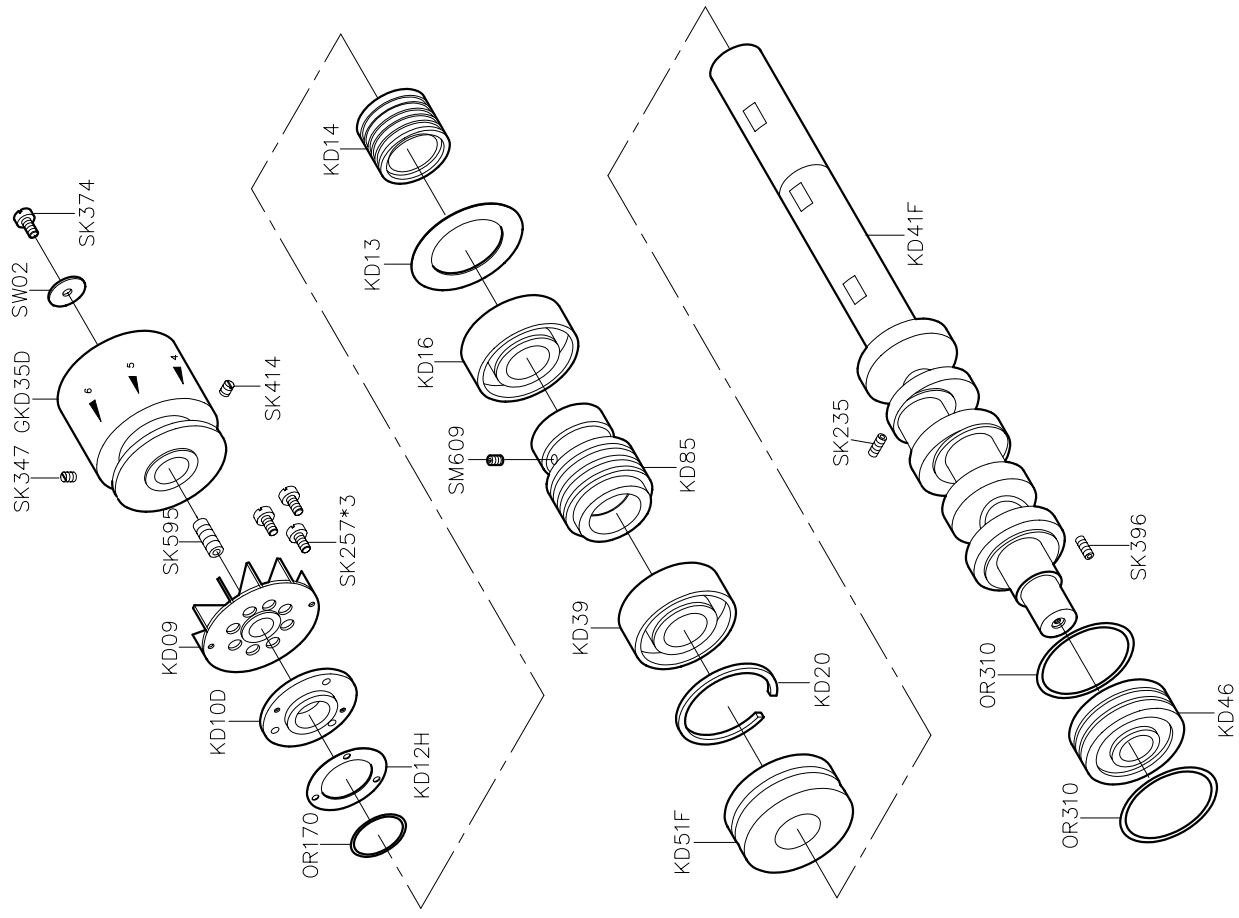

# PARTS LIST FOR KF GROUP

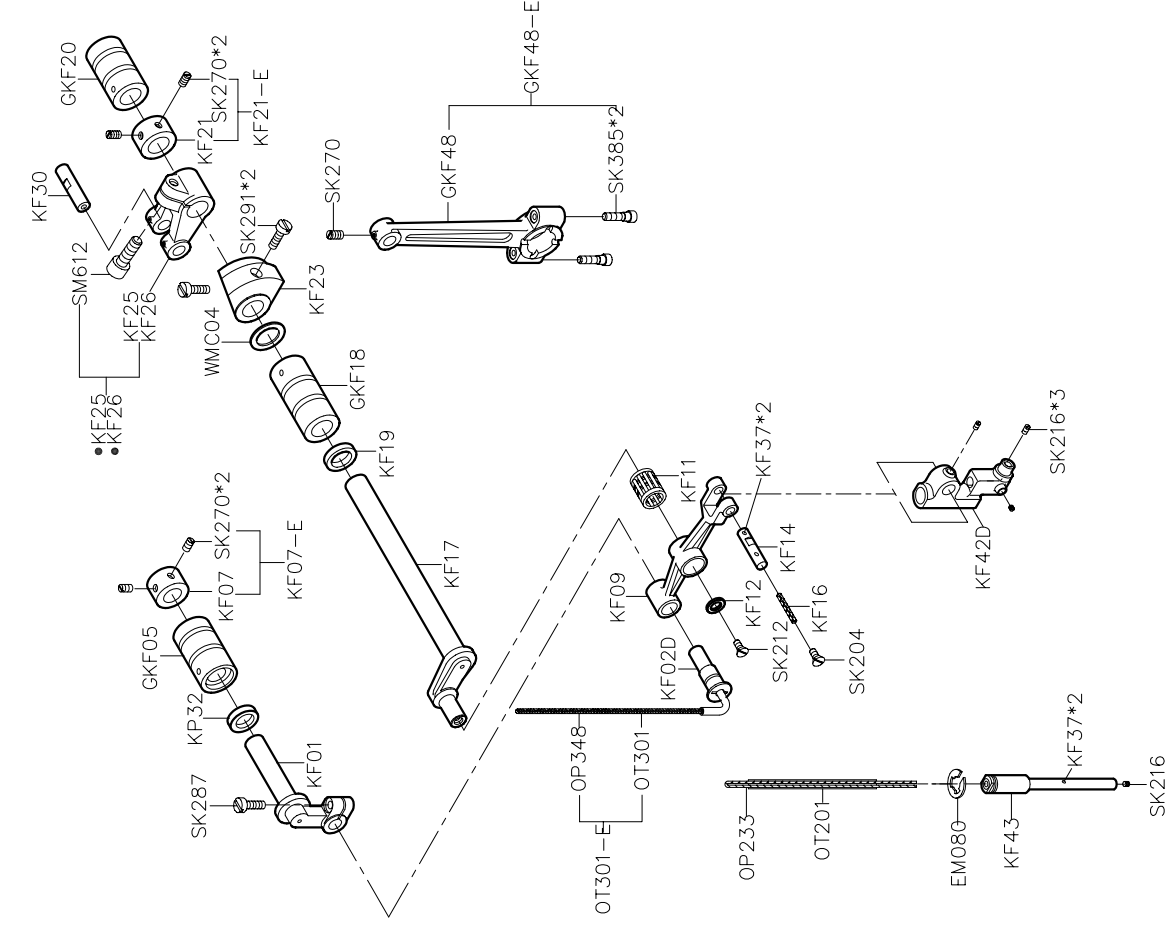

# PARTS LIST FOR KG GROUP

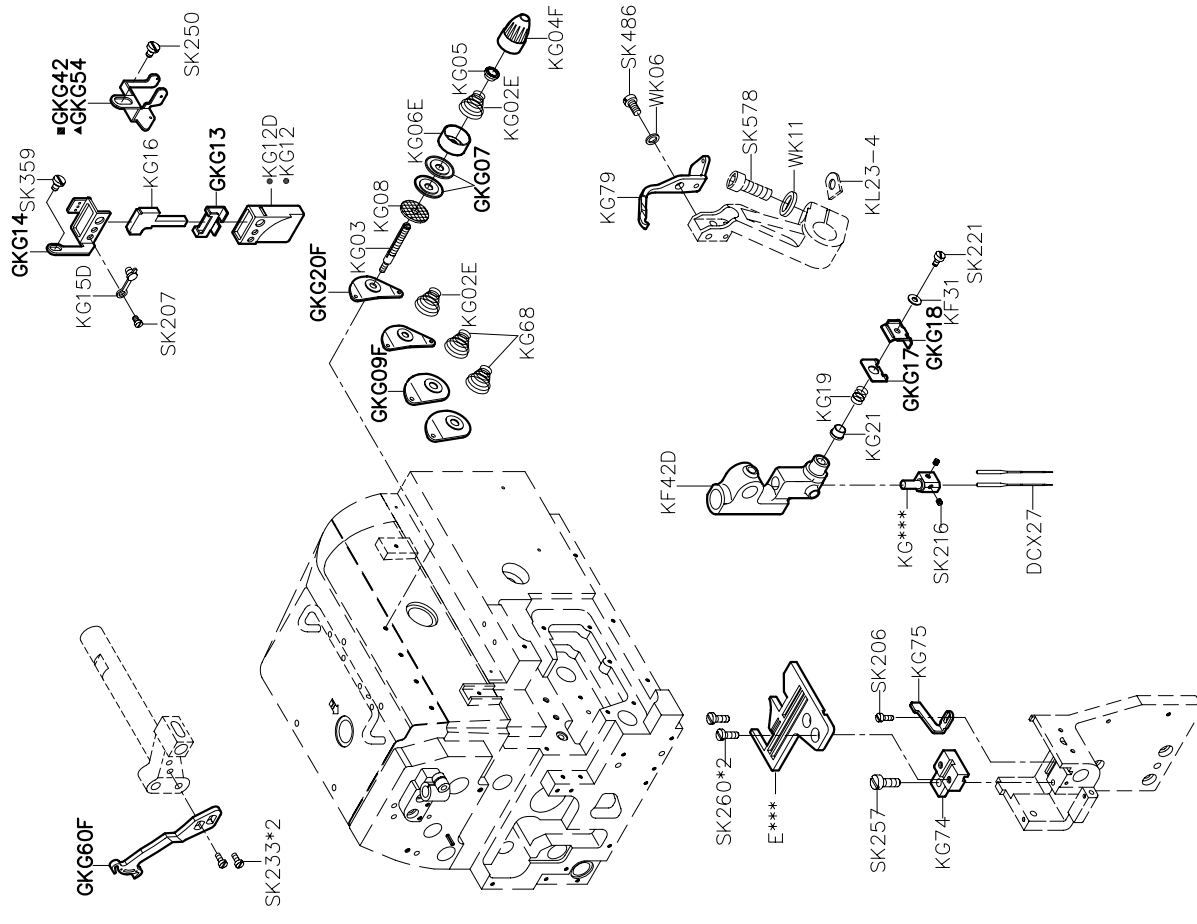

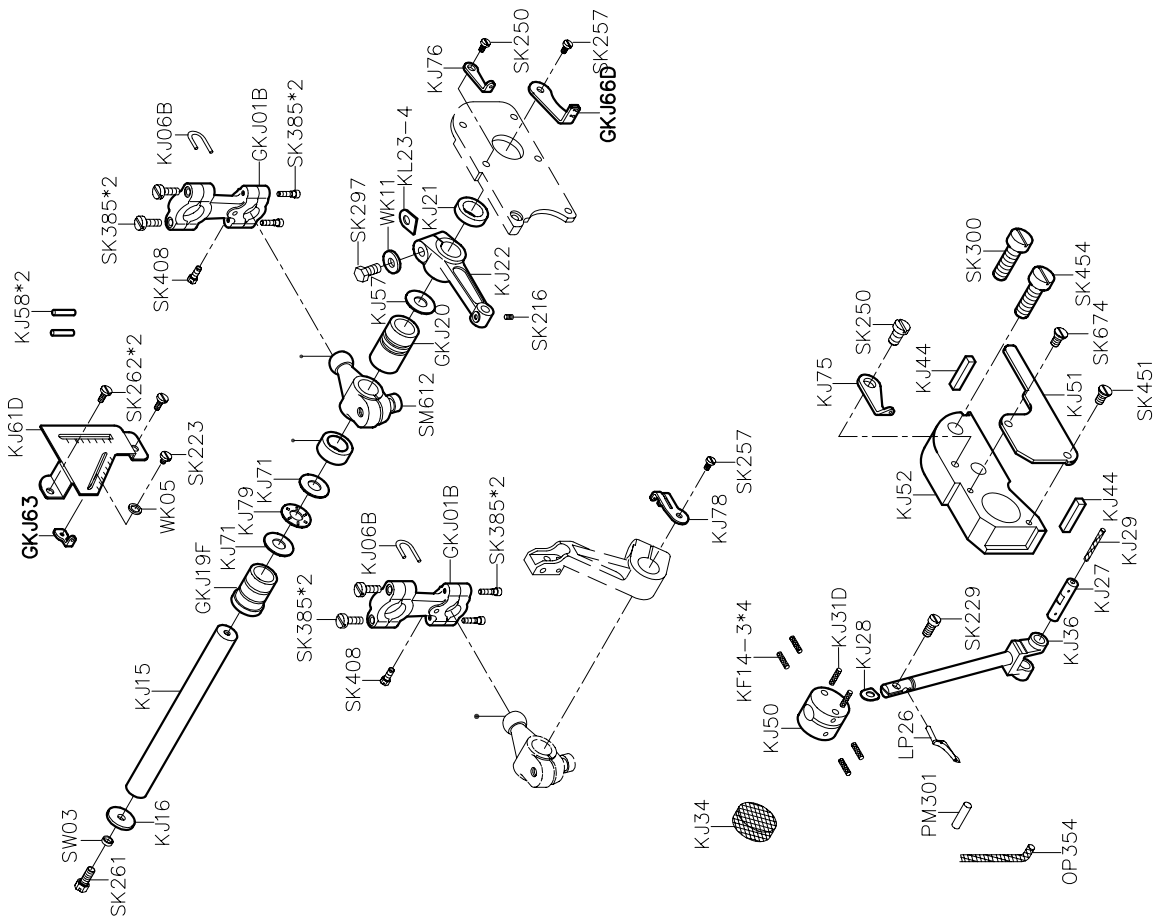
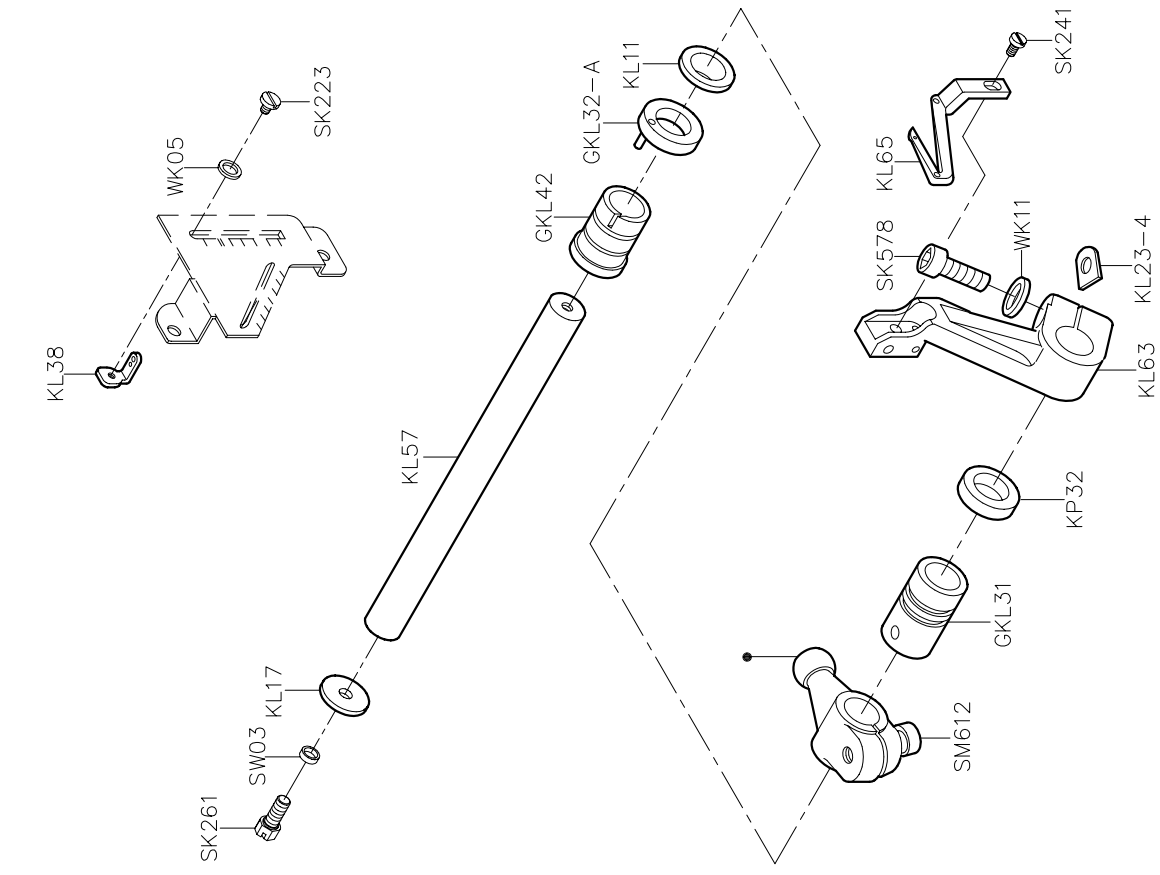

**PARTS LIST FOR KJ GROUP** From the library of: **Diamond Needle Corp** **PARTS LIST FOR KL GROUP**

**PARTS LIST FOR KP GROUP**

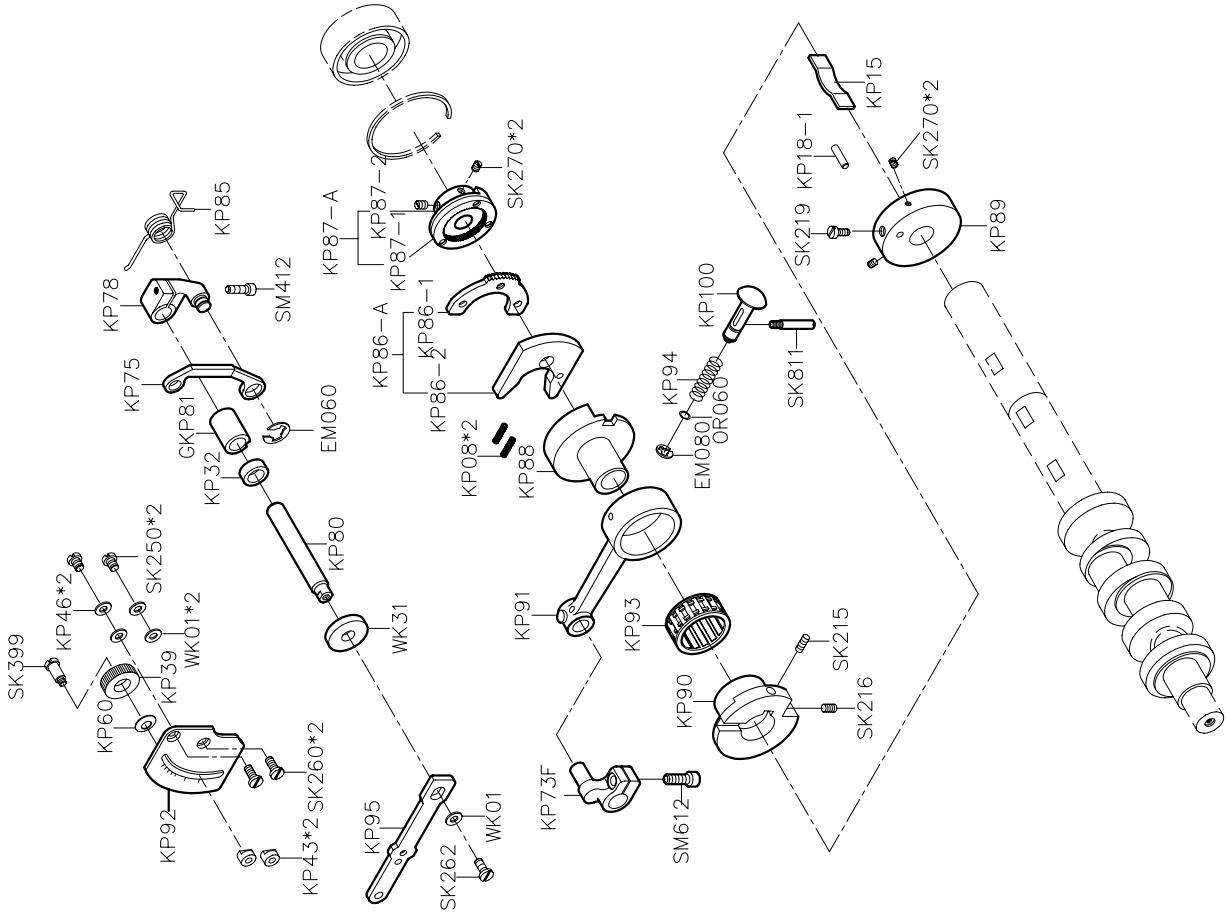

**PARTS LIST FOR KQ GROUP**

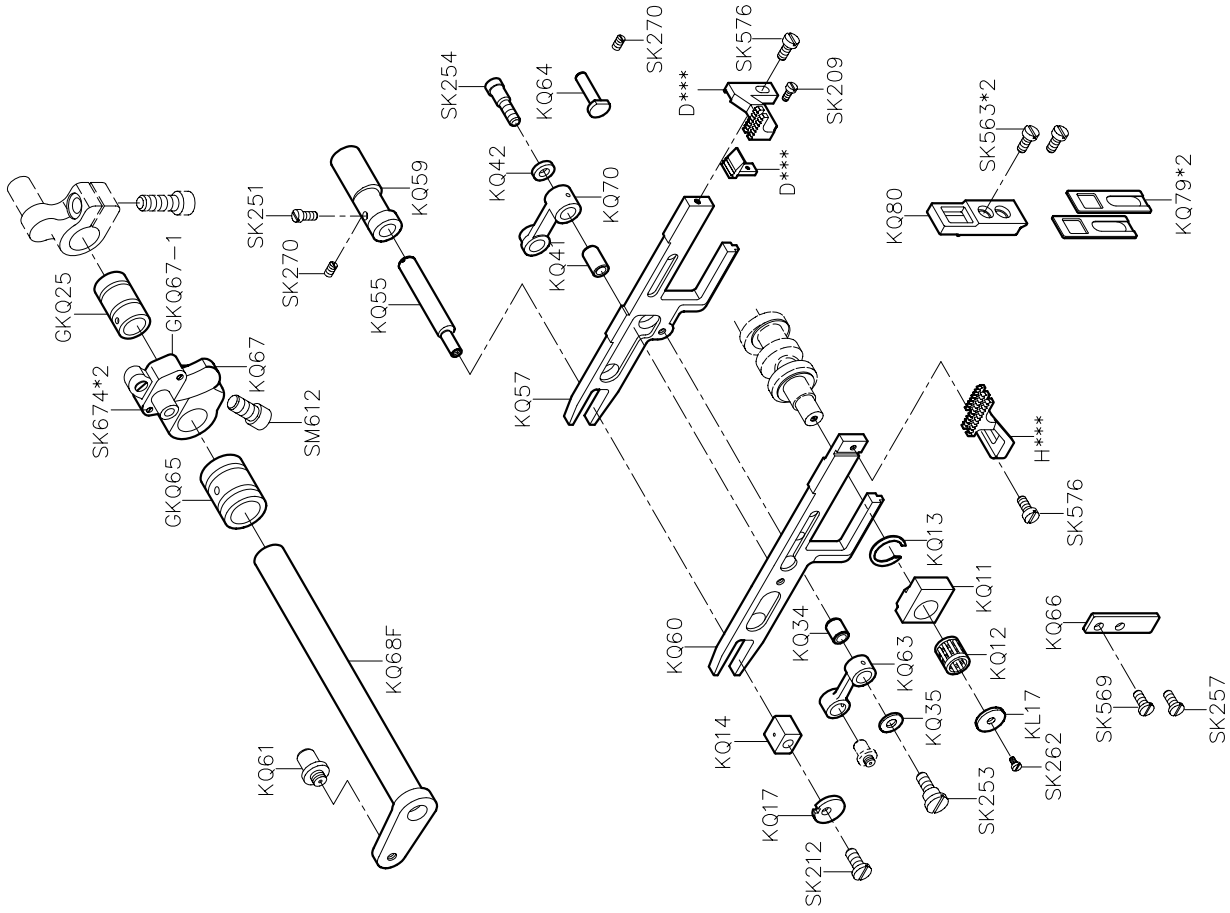

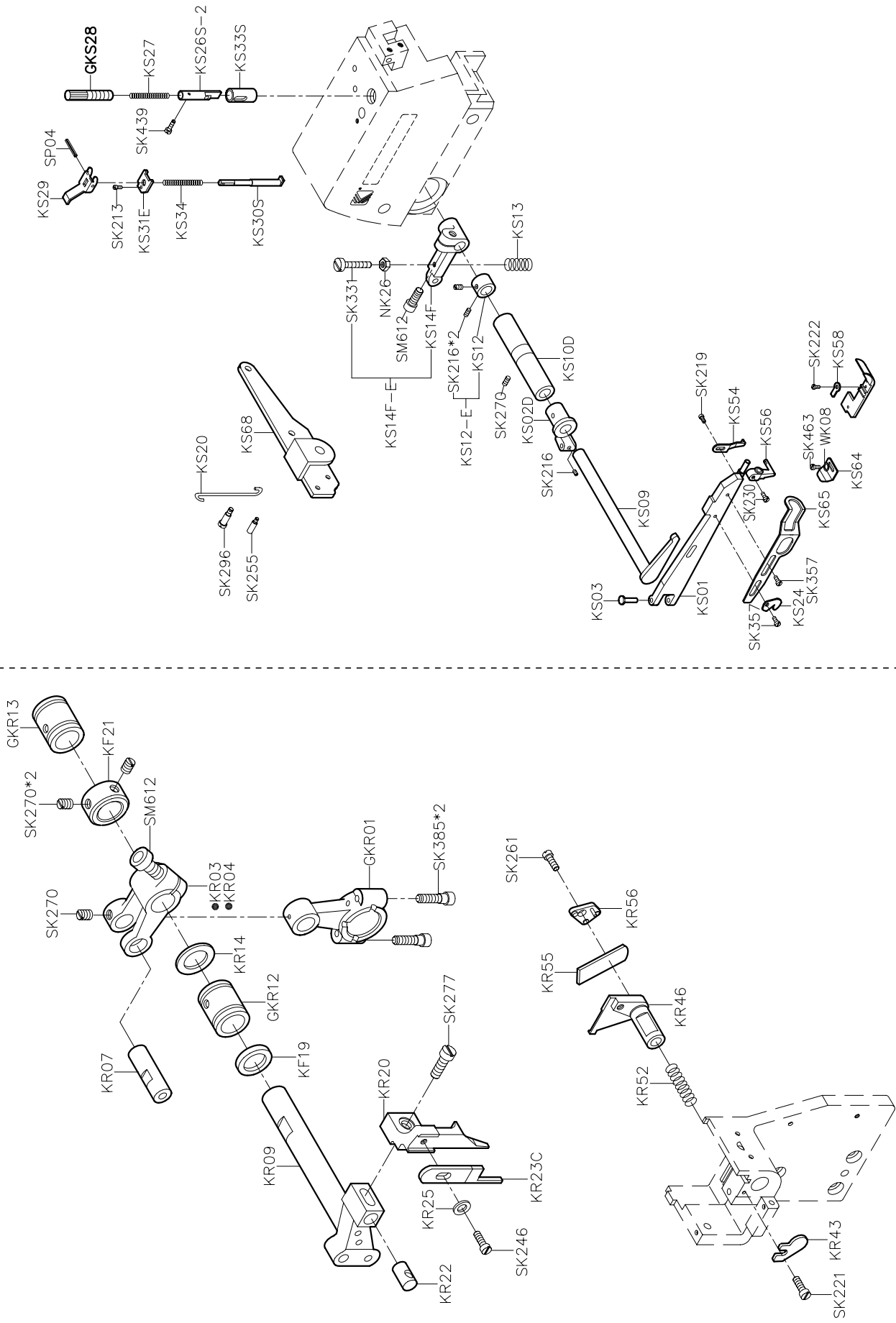



# PARTS LIST FOR KT GROUP

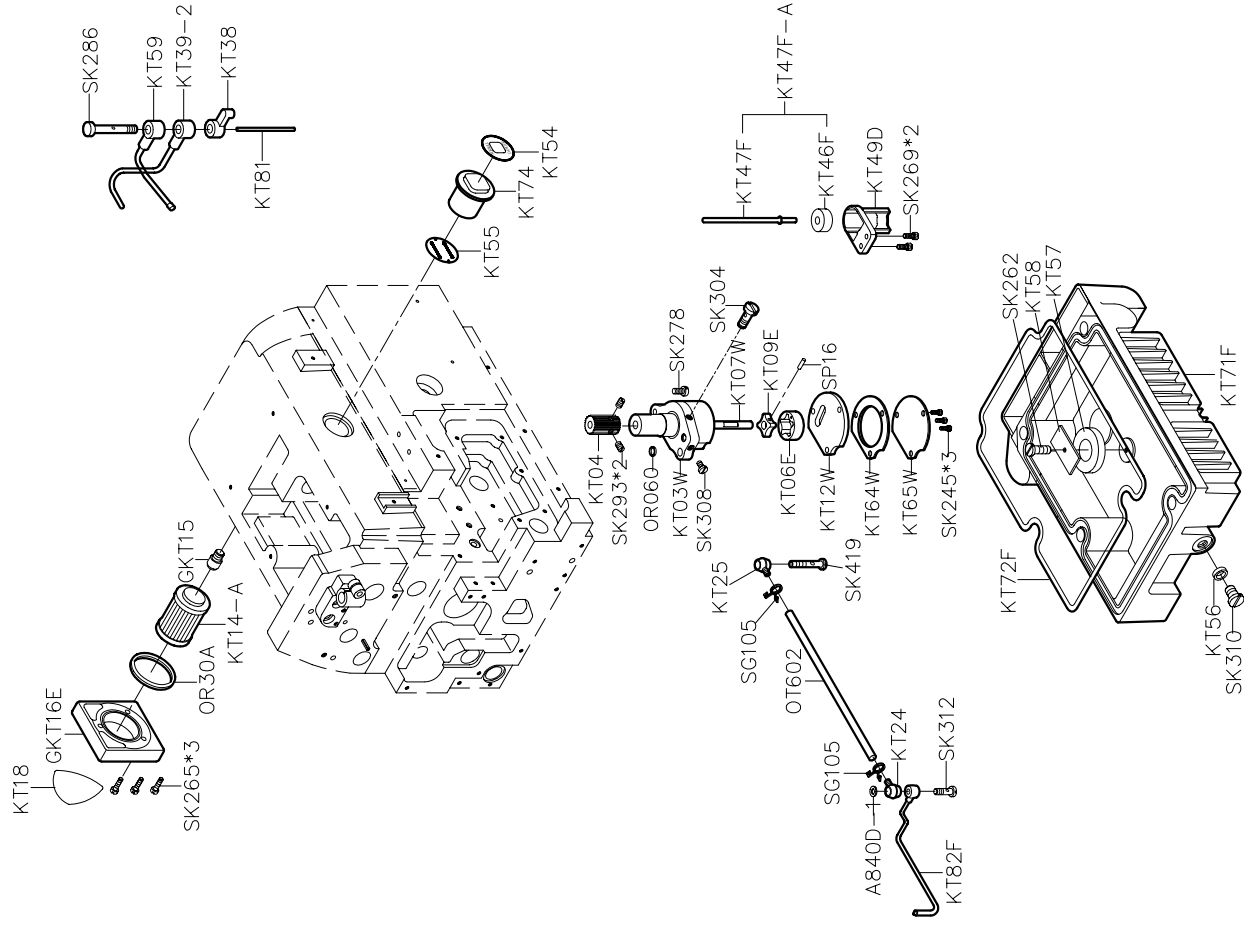

# PARTS LIST FOR KU GROUP

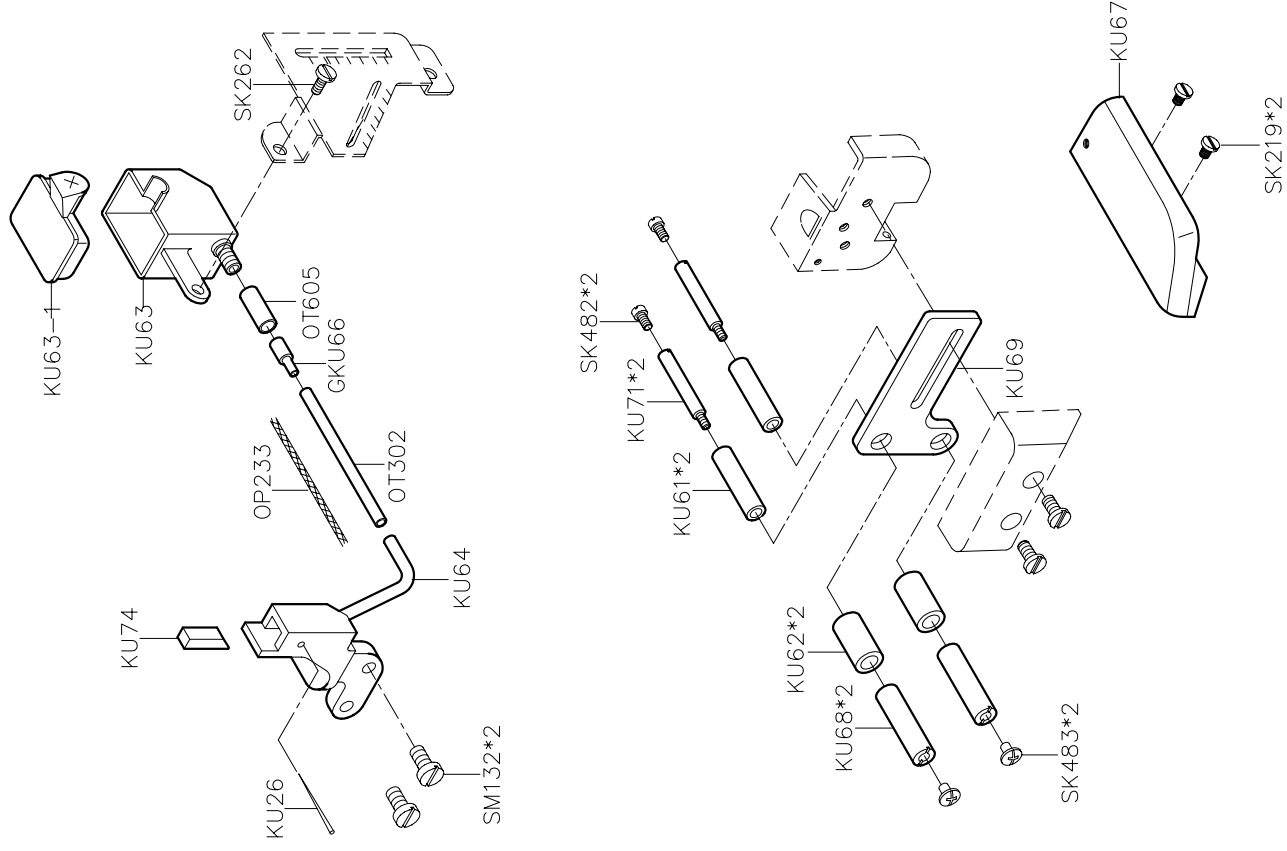



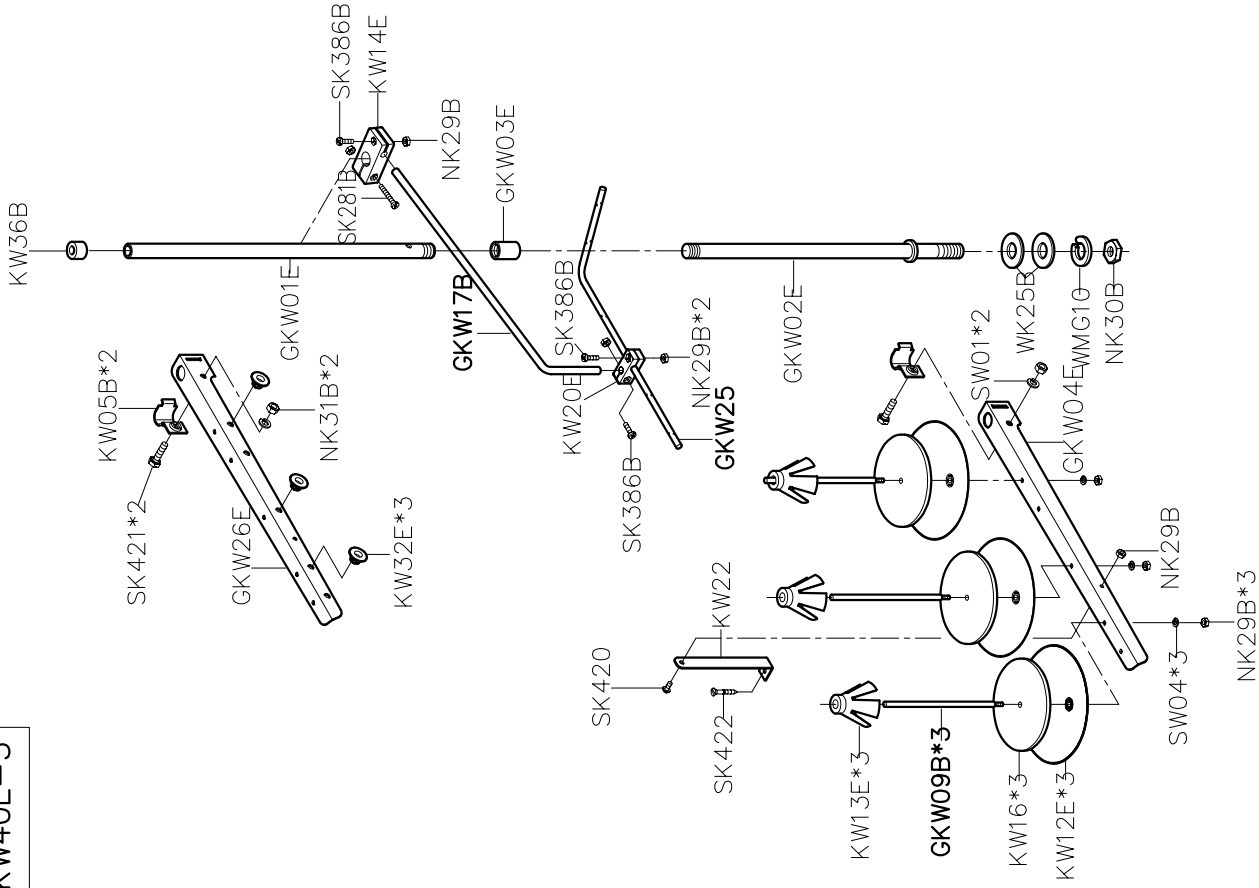



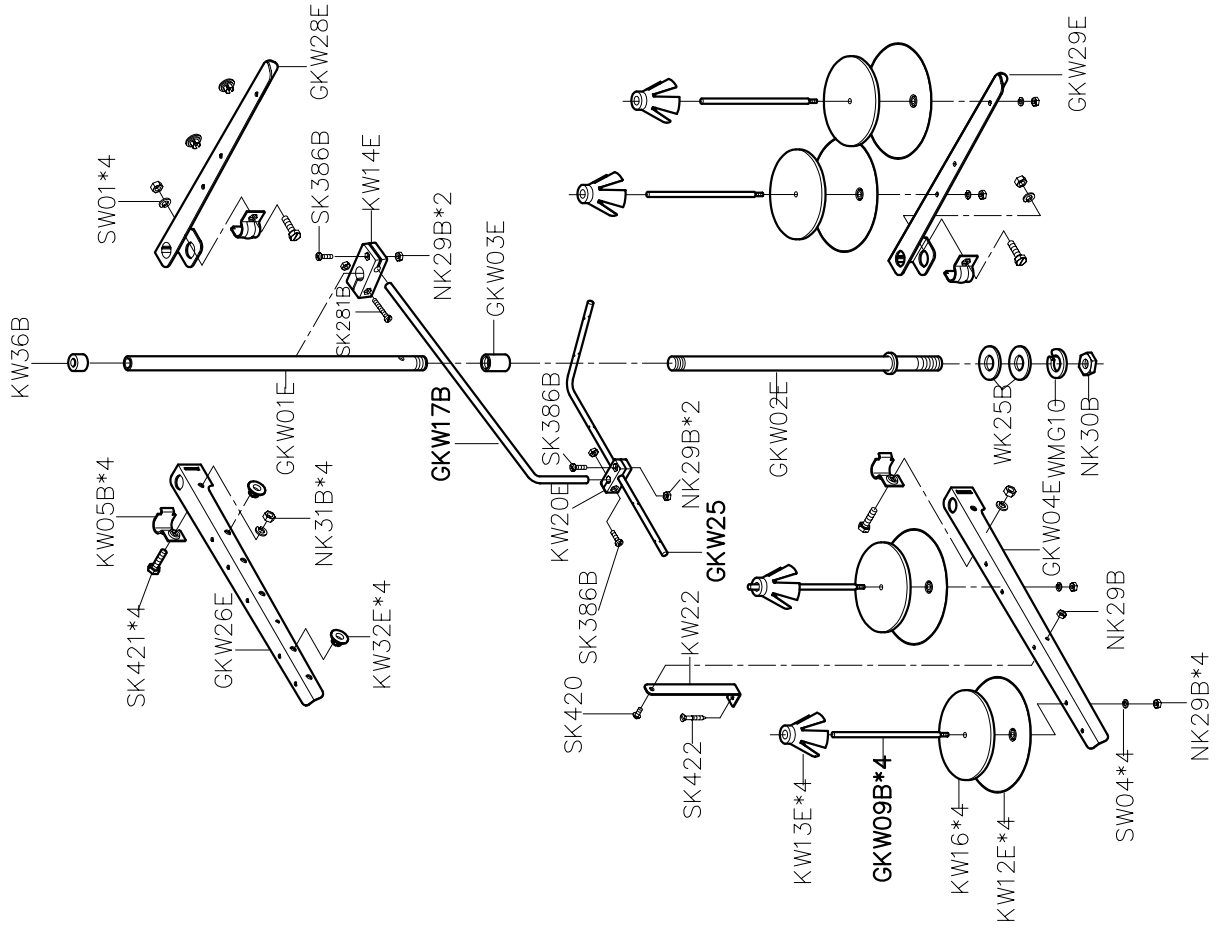

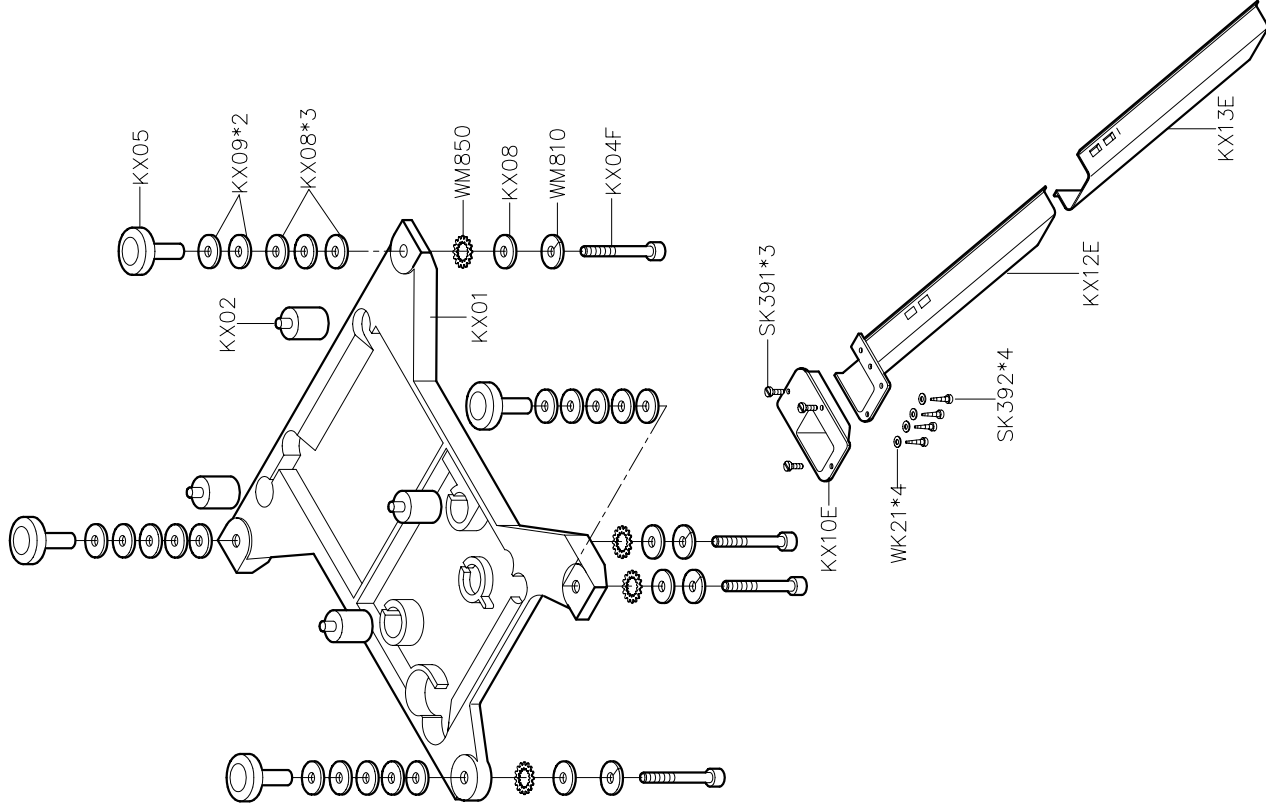



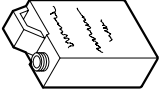
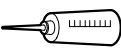











GKW40E-3



GKW40E-4



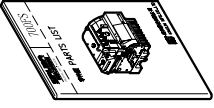
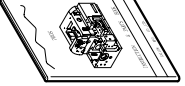

GKY01-1 防塵罩 	KY02-A 油罐 	KY03 油壺 	KY04S 漏斗 	KY05 油壺 
KY07 開口板手 	KY08 開口板手 	KY09 開口板手 	KY10 六角板手 	KY11 六角板手 
KY12 六角板手 	KY14 內六角螺絲起子 	KY16 一字起子 	KY17 一字起子 	KY18 鑪子 
GKY20D 腳踏板 	KY21-A/MY21 鉤子/鍊條 	GKY26F 工具袋 	KR55 下刀片 	KT14-A 濾油器 
MY11 六角板手 	KZ03 乾燥劑 	針*4 	KZ08FS 零件圖 	KZ13 使用說明書 
SK216 螺絲 	KY30 針板紙 			

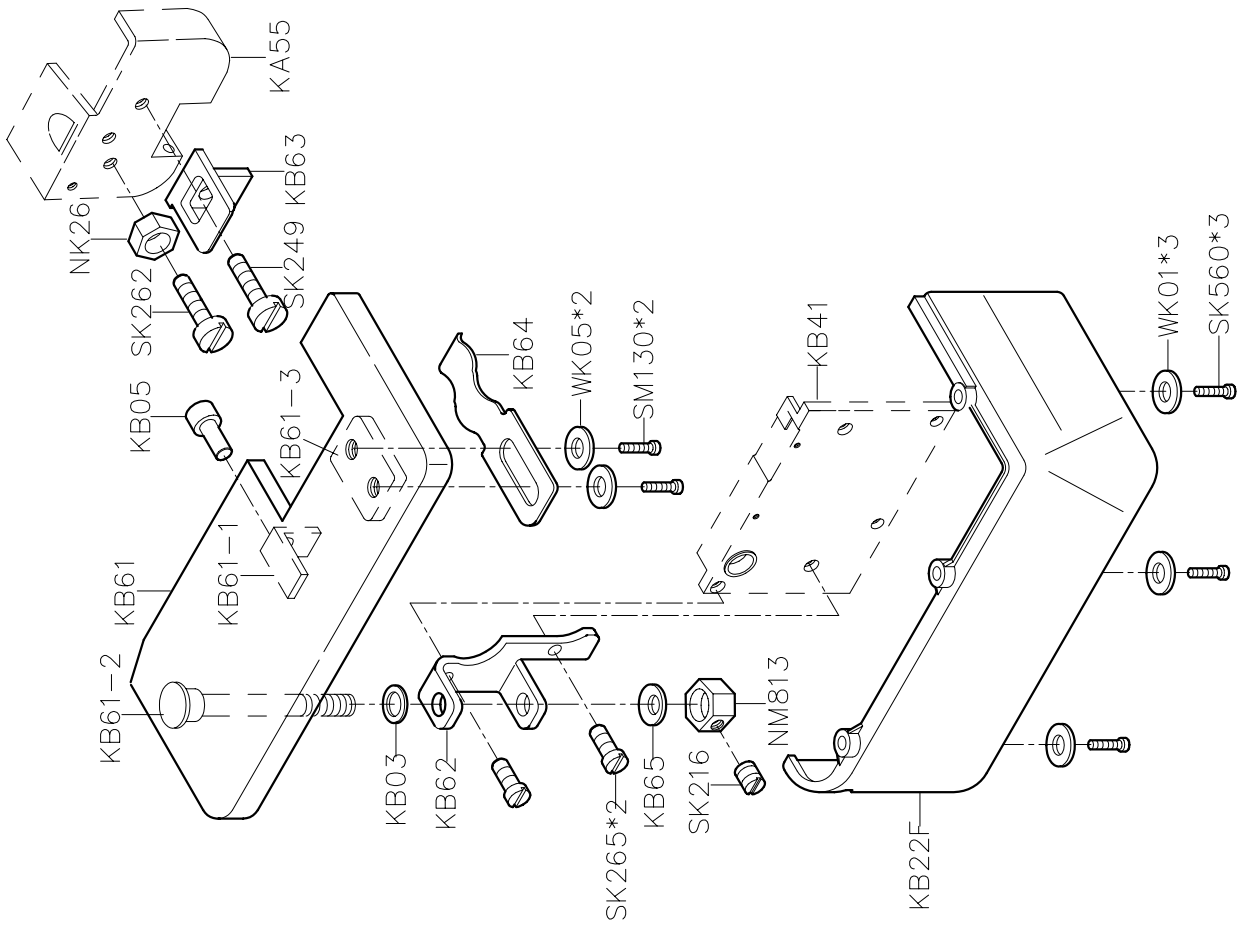
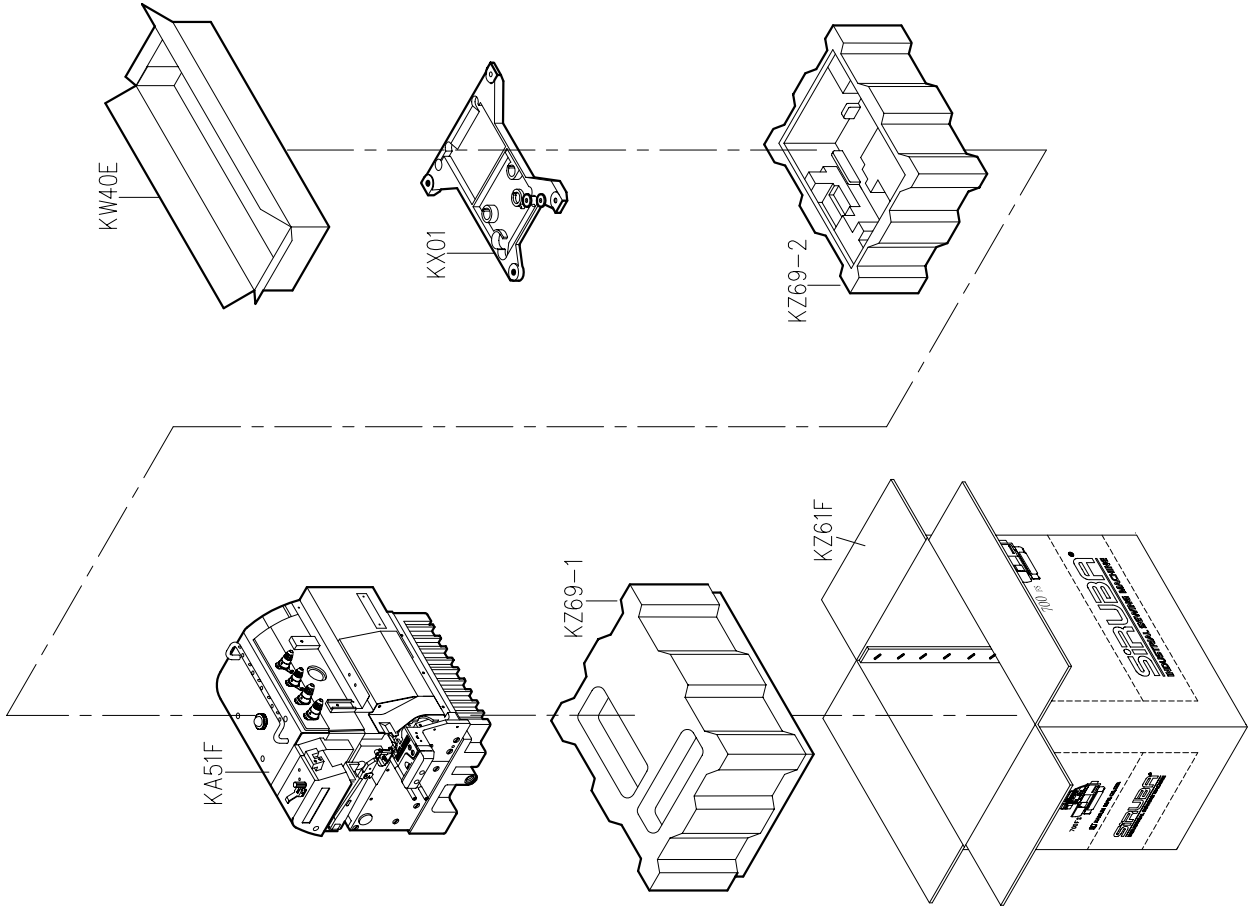

700FS ATTACHMENT

# PARTS LIST FOR ESS (1) GROUP

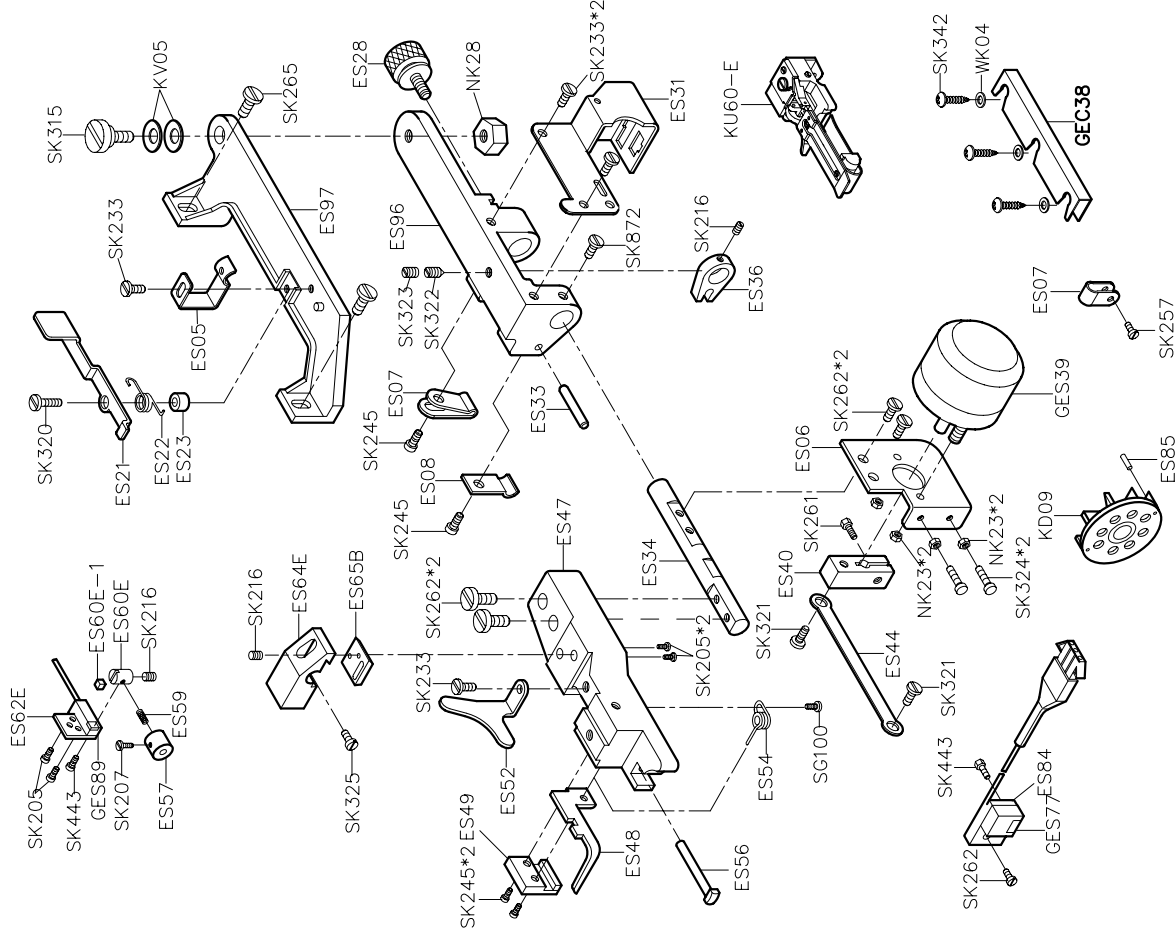

700FS ATTACHMENT

# PARTS LIST FOR ESS (2) GROUP

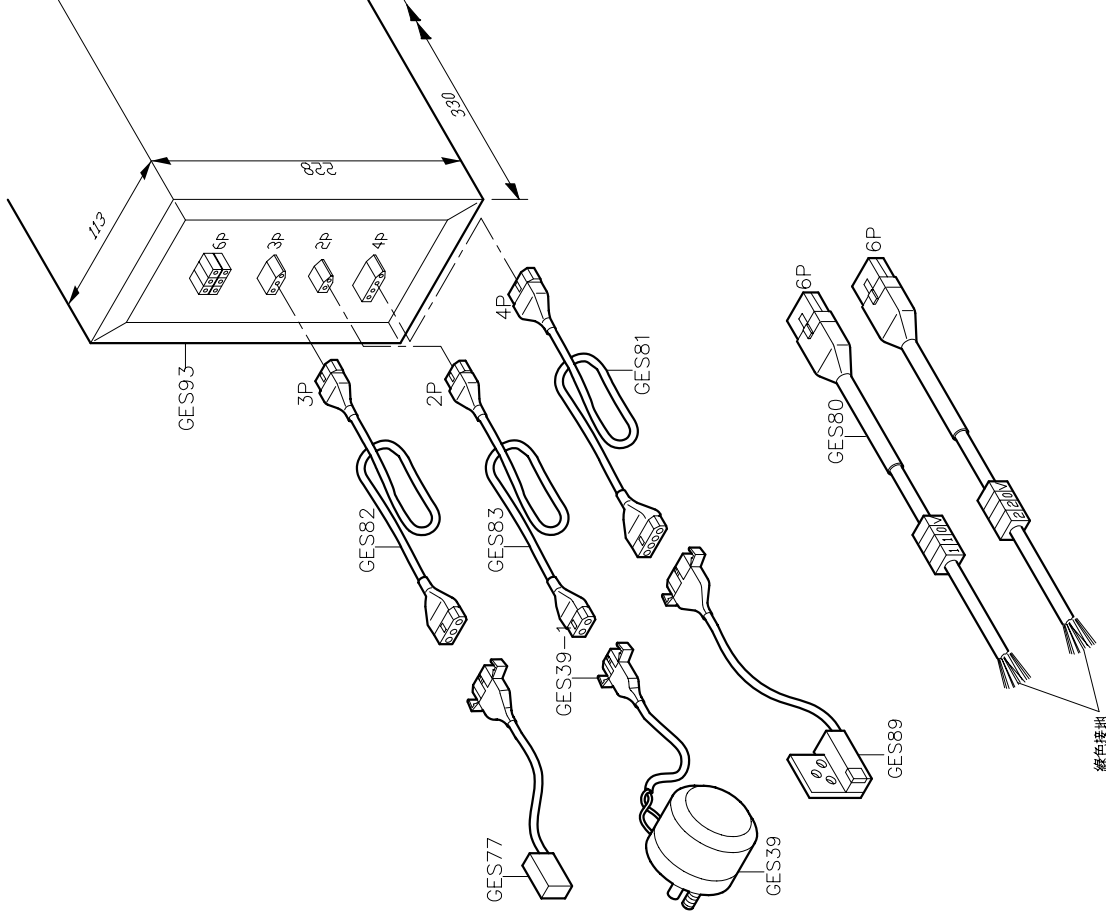

※ 內銷版上110V及220V各一條  
外銷已指定地區則只附上一條110V或220V

700FS ATTACHMENT

## 700FS ATTACHMENT

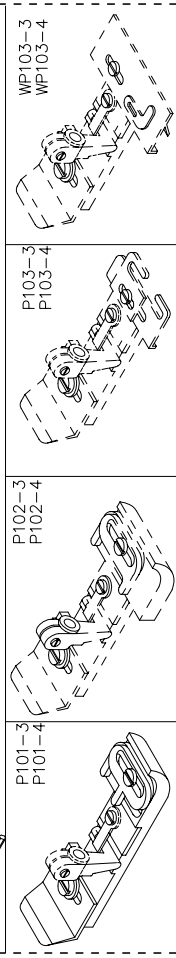
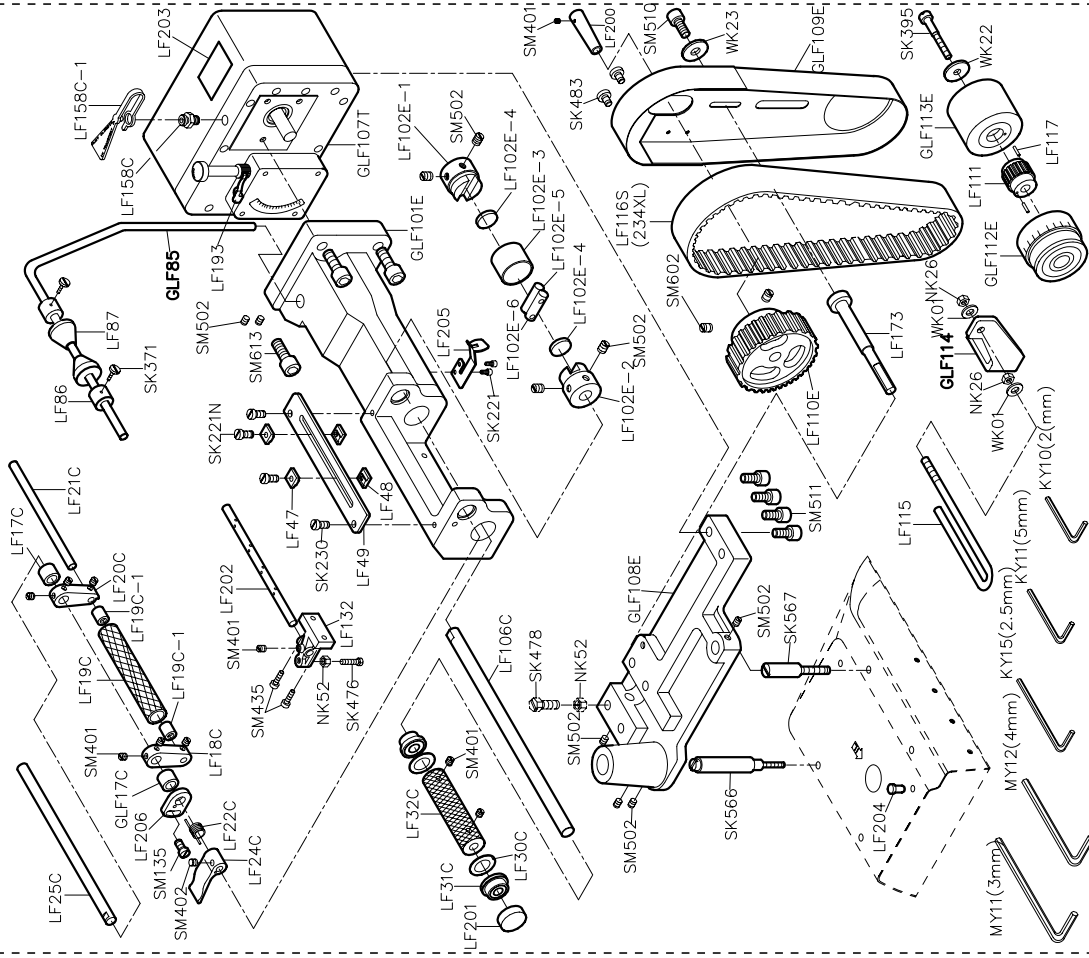





# 700FS

高林股份有限公司 KAULIN MFG. CO., LTD.

From the library of: Diamond Needle Corp